

OC036-STP POLY STAND

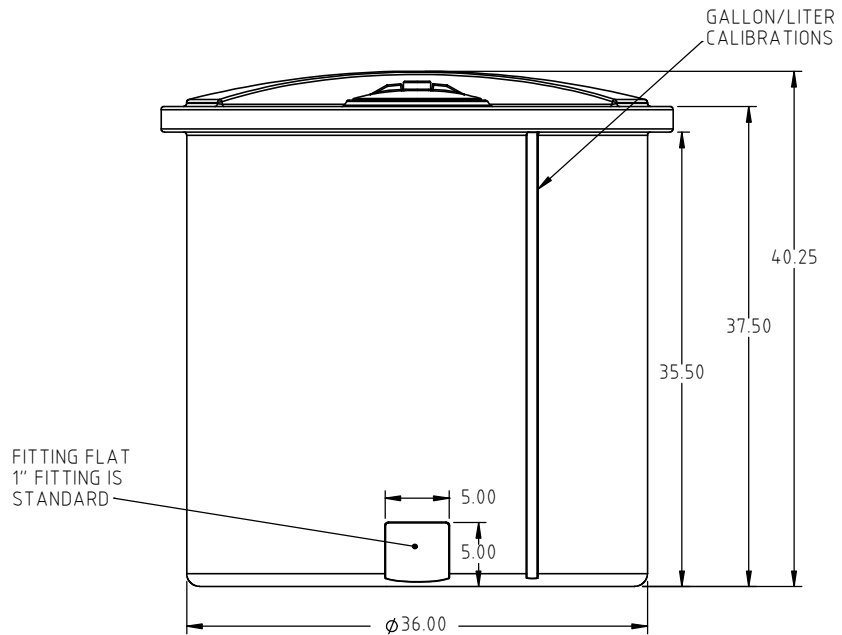
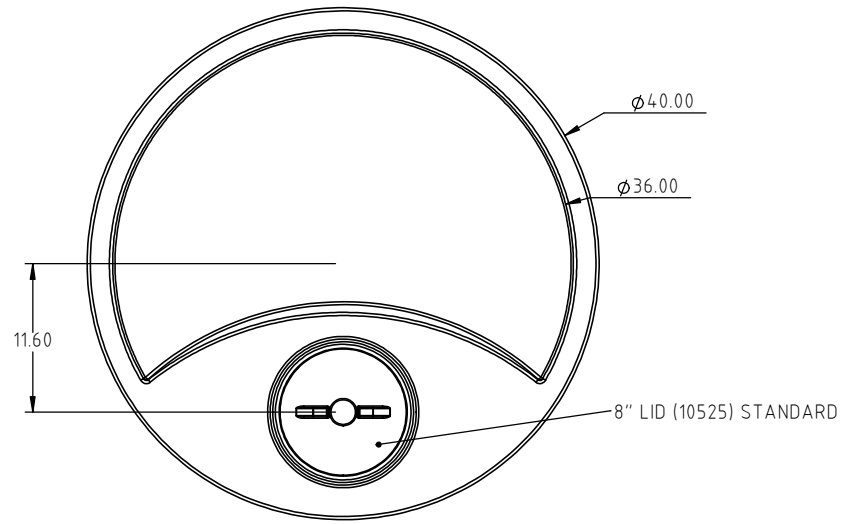

TITLE: C145FTA

DESCRIPTION:
145 GALLON VERTICAL TANK

NOTES:
POLYETHYLENE ± 1% @ 68°F
METAL DECIMAL ± .125"
FRACTION ± 1/4"
ANGLE ± 1°

.20 WALL

SHOT WEIGHT: 50 LBS.
SHIPPING WEIGHT: 52 LBS.
MATERIAL: 10420
NOTES:
REV.:

DRAWN: SK

DATE: 10/3/16

REV: 1

SCALE: N/A

PROPRIETARY INFORMATION
THE INFORMATION ON THIS DOCUMENT IS THE PROPERTY OF FLUIDALL, LLC. DOCUMENT IS SUBJECT TO RETURN UPON DEMAND AND MAY NOT BE REPRODUCED OR DISCLOSED WITHOUT THE WRITTEN PERMISSION OF FLUIDALL, LLC.



860 Johnson Drive
Delano, MN 55328
www.fluidall.com